



www.jdsemi.cn

深圳市晶导电子有限公司

ShenZhen Jingdao Electronic Co.,Ltd.

CM13N45C

POWER MOSFET

## 1、主要参数 Main Characteristics

## 2、用途 Applications

- 高频开关电源 High frequency switching mode power supply
- 电子镇流器 Electronic ballast
- UPS 电源 Uninterruptible Power Supply
- PFC 功率因数校正 Power Factor Correction
- 大功率开关电源 High power switching power supply
- 电焊机控制 Control of electric welding machine

## 3、产品特性 Features

- 低栅极电荷 Low gate charge
- 低 Crss (典型值 20pF) Low Crss (typical 20pF)
- 开关速度快 Fast switching speed
- 产品全部经过雪崩测试 100% avalanche tested
- 高抗 dv/dt 能力 Improved dv/dt capability
- RoHS 产品 RoHS product

## 4. 电特性 Electrical Characteristics

### 4.1 极限值 Absolute Ratings (T<sub>c</sub> = 25℃)

参数名称 Parameter	符号 Symbol	额定值 Value	单位 Unit
漏极-源极电压 Drain-Source Voltage	V <sub>DSS</sub>	450	V
连续漏极电流 Drain Current -continuous	I <sub>D</sub>	T <sub>c</sub> = 25 °C	13
		T <sub>c</sub> = 100 °C	7.8
最大脉冲漏极电流 (注 1) Drain Current - pulse (note 1)	I <sub>DM</sub>	52	A
栅源电压 Gate-Source Voltage	V <sub>GS</sub>	±30	V
单脉冲雪崩能量 (注 2) Single Pulsed Avalanche Energy (note 2)	E <sub>AS</sub>	450	mJ
二极管反向恢复最大电压变化速率 (注 3) Peak Diode Recovery dv/dt (note 3)	dv/dt	5.0	V/ns
耗散功率 Power Dissipation	P <sub>D</sub>	65	W
结温, 贮存温度 Operating and Storage Temperature Range	T <sub>j</sub> , T <sub>stg</sub>	150, -55~150	°C

V <sub>DSS</sub>	450	V
I <sub>D</sub>	13	A
P <sub>D</sub>	65	W
R <sub>DS(on)(TYP)</sub>	0.44	Ω

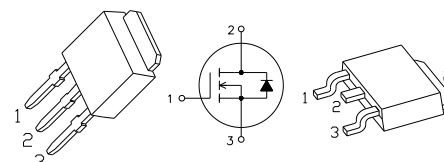

TO-251S

TO-252S

1 栅极(G) 2 漏极 (D) 3 源极(S)



www.jdsemi.cn

深圳市晶导电子有限公司

ShenZhen Jingdao Electronic Co.,Ltd.

CM13N45C

POWER MOSFET

4.2 电参数 Electrical Characteristics (T<sub>C</sub> = 25°C)

参数名称 Parameter	符号 Symbol	测试条件 Tests conditions	最小 Min	典型 Typ	最大 Max	单位 Units
<b>截止特性 Off-Characteristics</b>						
漏源击穿电压 Drain-Source Voltage	BV <sub>DSS</sub>	V <sub>GS</sub> =0V, I <sub>D</sub> =250μA	450			V
漏源击穿电压温度系数 Breakdown Voltage Temperature Coefficient	Δ BV <sub>DSS</sub> / ΔT <sub>J</sub>	I <sub>D</sub> = 250 μA		0.5		V/°C
漏源漏电流 Zero Gate Voltage Drain Current	I <sub>DSS</sub>	V <sub>DS</sub> =450V, V <sub>GS</sub> =0, 25°C V <sub>DS</sub> =350V, V <sub>GS</sub> =0, 125°C			1 100	μA
栅源漏电流 Gate-body leakage current	I <sub>GSS</sub>	V <sub>GS</sub> = ±30V			±100	nA
<b>导通特性 On-Characteristics</b>						
静态导通电阻 Static Drain-Source On-Resistance	R <sub>DS(on)</sub> *	V <sub>GS</sub> =10V, I <sub>D</sub> =6A		0.44	0.49	Ω
阈值电压 Gate Threshold Voltage	V <sub>GS(th)</sub>	V <sub>DS</sub> =V <sub>GS</sub> , I <sub>D</sub> =250μA	2		4	V
跨导 Forward Transconductance	g <sub>fs</sub>	V <sub>DS</sub> =15V, I <sub>D</sub> =6A		6		S
脉冲宽度 tp≤380μs, 占空比 δ≤2%						
<b>动态特性 Dynamic Characteristics</b>						
输入电容 Input capacitance	C <sub>iss</sub>	V <sub>GS</sub> =0V, V <sub>DS</sub> =25V f=1.0MH		1000		pF
输出电容 Output capacitance	C <sub>oss</sub>			73		
反向传输电容 Reverse transfer capacitance	C <sub>rss</sub>			20		
<b>开关特性 Switching Characteristics</b>						
开启延迟(时间) Turn-On delay time	t <sub>d(ON)</sub>	I <sub>D</sub> = 12.0A V <sub>DD</sub> = 250V V <sub>GS</sub> = 10V R <sub>G</sub> = 6.1Ω		18		nS
上升时间 Turn-On rise time	t <sub>r</sub>			23		
关断延迟(时间) Turn-Off delay time	t <sub>d(OFF)</sub>			41		
下降时间 Turn-Off Fall time	t <sub>f</sub>			19		
栅极电荷 Total Gate Charge	Q <sub>g</sub>	I <sub>D</sub> =12A, V <sub>DD</sub> =250V V <sub>GS</sub> = 10V		27.8		nC
栅源电荷 Gate-Source charge	Q <sub>gs</sub>			8.9		
栅漏电荷 Gate-Drain charge	Q <sub>gd</sub>			9.6		

地址：深圳市宝安区石岩街道洲石路中集创谷产业园 B 栋 1-3 层 电话：0755-29799516 传真：0755-29799515



www.jdsemi.cn

深圳市晶导电子有限公司

ShenZhen Jingdao Electronic Co.,Ltd.

CM13N45C

POWER MOSFET

源-漏二极管特性 Drain-Source Diode Characteristics						
源漏二极管连续电流 Maximum Continuous Drain -Source Diode Forward Current	$I_{SD}$	$T_c = 25\text{ }^\circ\text{C}$			10	A
源漏二极管脉冲电流 Maximum Pulsed Drain-Source Diode Forward Current	$I_{SDM}$				40	A
源漏二极管正向压降 Drain-Source Diode Forward Voltage	$V_{FSD}$	$I_{SD}=12\text{A}, V_{GS}=0$			1.5	V
反向恢复时间 Reverse recovery time	$t_{rr}$	$I_{SD}=12\text{A}, T_j = 25\text{ }^\circ\text{C}$ $dI_F/dt=100\text{A}/\mu\text{s}, V_{GS}=0\text{V}$			376	nS
反向恢复电荷 Reverse recovery charge	$Q_{rr}$				2560	nC

参数名称 Parameter	符号 Symbol	额定值 Value	单位 Unit
热阻（结到壳） Thermal Resistance, Junction to Case	$R_{\theta JC}$	1.92	$^\circ\text{C}/\text{W}$
热阻（结到环境） Thermal Resistance, Junction to Ambient	$R_{\theta JA}$	62.5	$^\circ\text{C}/\text{W}$

注:

- 1 重复脉冲, 宽度由最高结温限制
- 2  $L=10\text{mH}, I_D=9.5\text{A}$ , 起始结温  $T_j=25\text{ }^\circ\text{C}$
- 3  $I_{SD}=12\text{A}, di/dt \leq 100\text{A}/\mu\text{s}, V_{DD} \leq BV_{DS}$ ,  
起始结温  $T_j=25\text{ }^\circ\text{C}$

Notes:

- 1 Pulse width limited by maximum junction temperature
- 2  $L=10\text{mH}, I_D=9.5\text{A}$ , Starting  $T_j=25\text{ }^\circ\text{C}$
- 3  $I_{SD}=12\text{A}, di/dt \leq 100\text{A}/\mu\text{s}, V_{DD} \leq BV_{DS}$ ,  
Starting  $T_j=25\text{ }^\circ\text{C}$

5. 特性曲线 Characteristics Curve

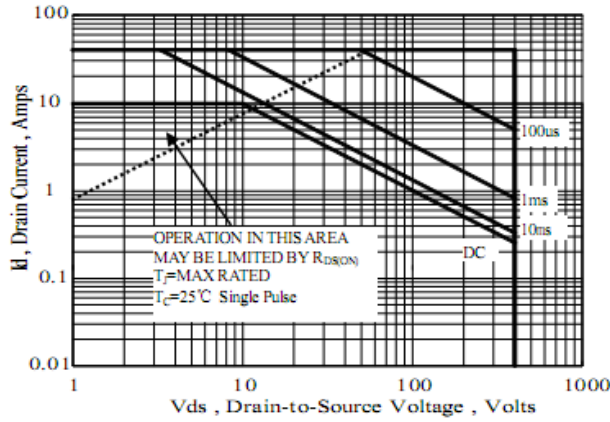

Figure 1 Maximum Forward Bias Safe Operating Area

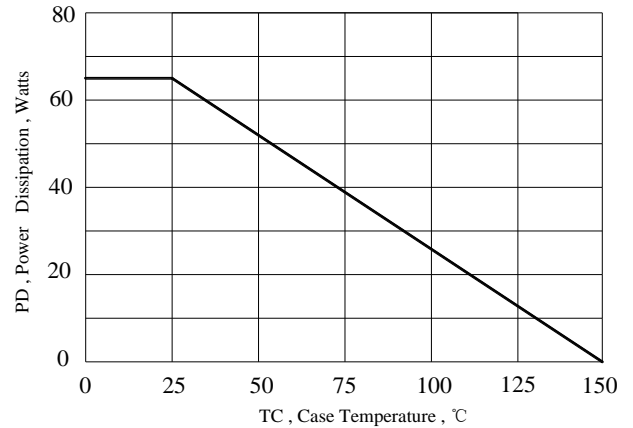

Figure 2, Maximum Power Dissipation vs Case Temperature

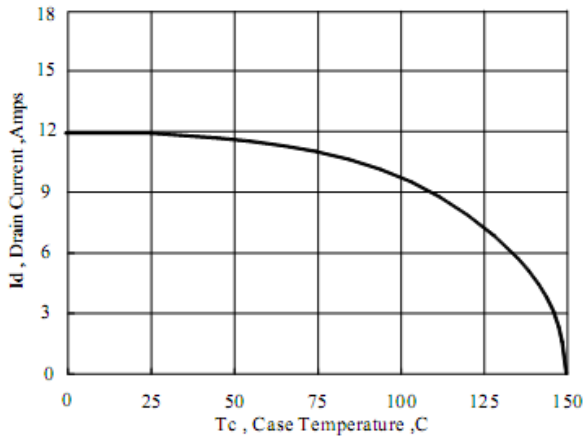

Figure 3 Maximum Continuous Drain Current vs Case Temperature

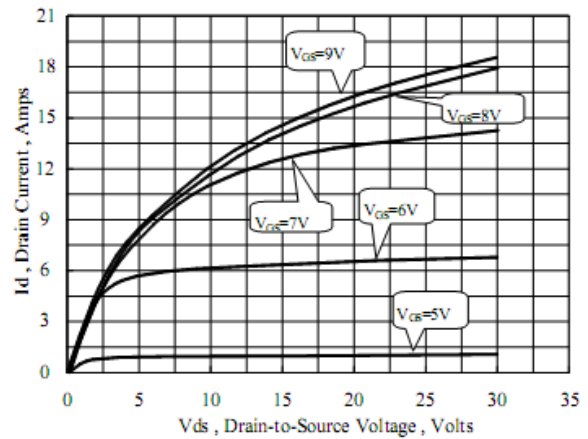

Figure 4 Typical Output Characteristics

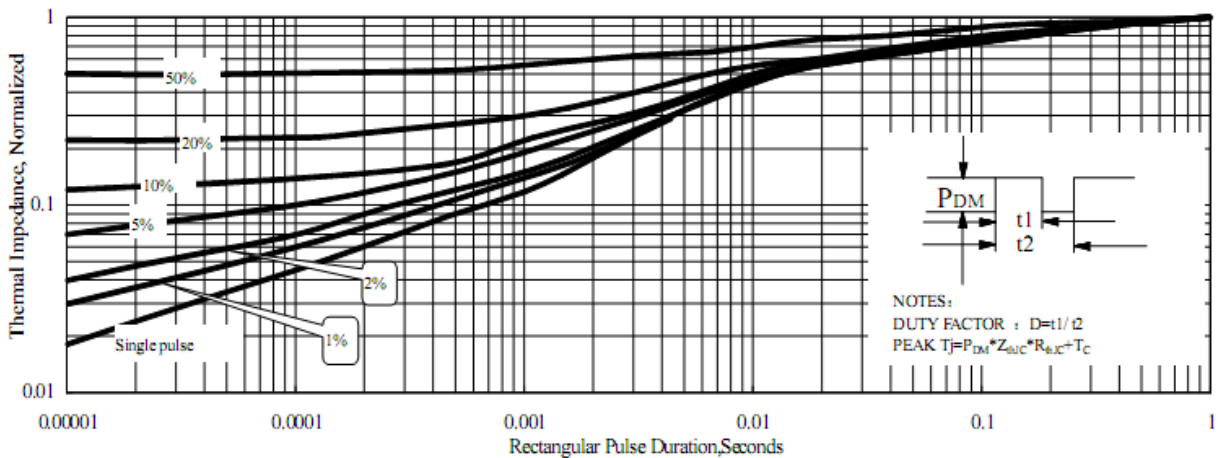
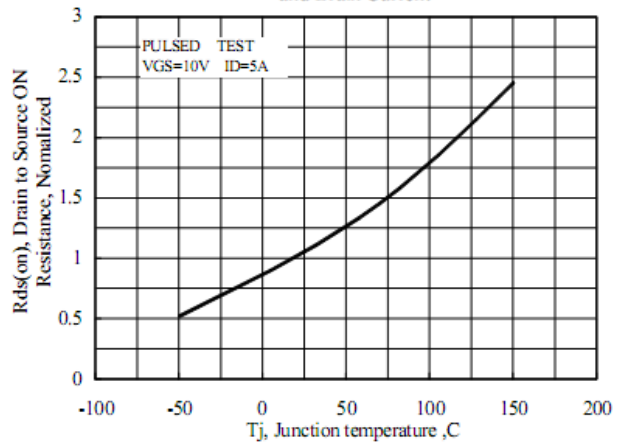
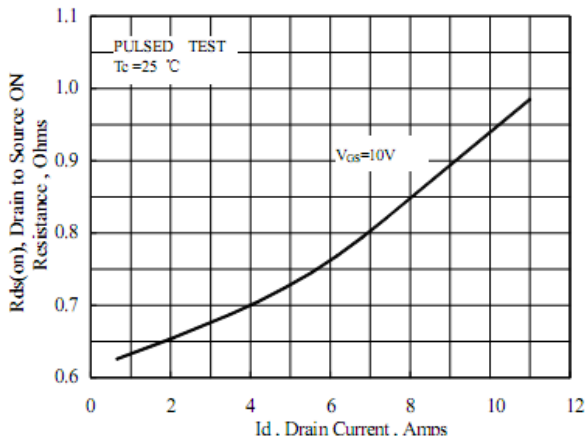
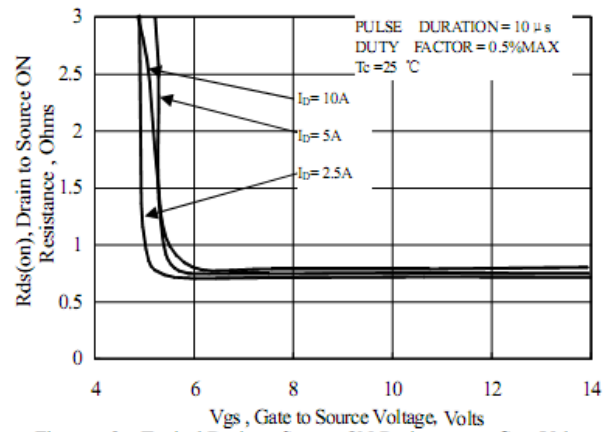
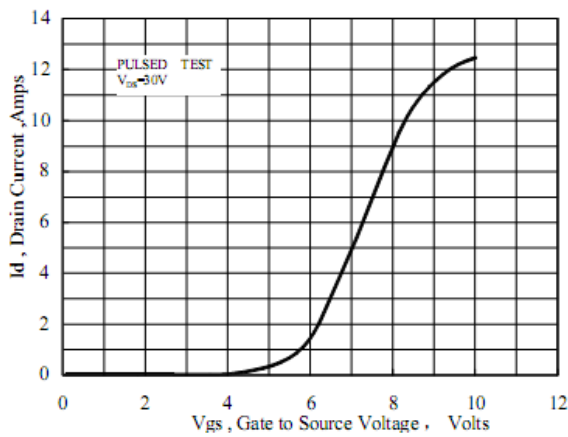
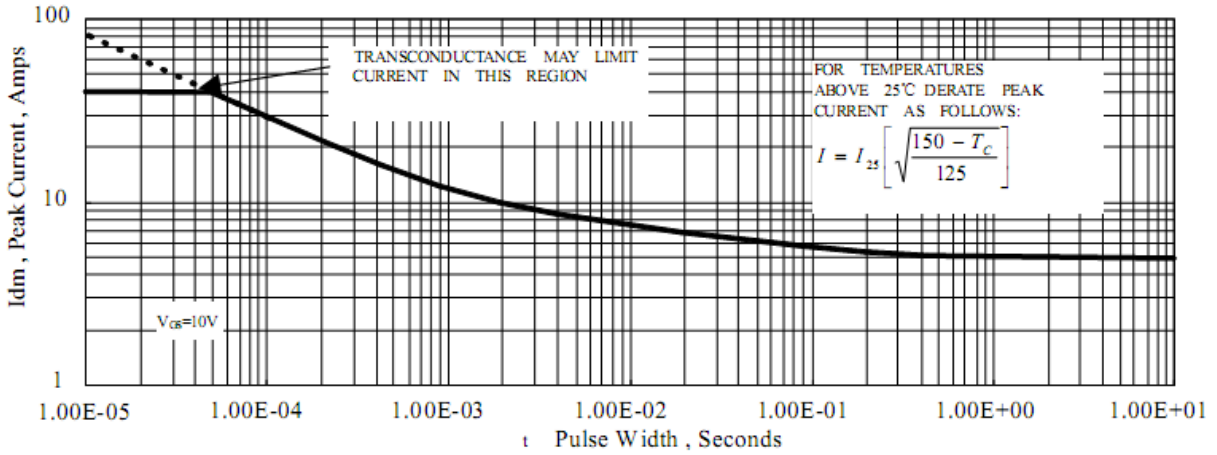

Figure 5 Maximum Effective Thermal Impedance, Junction to Case



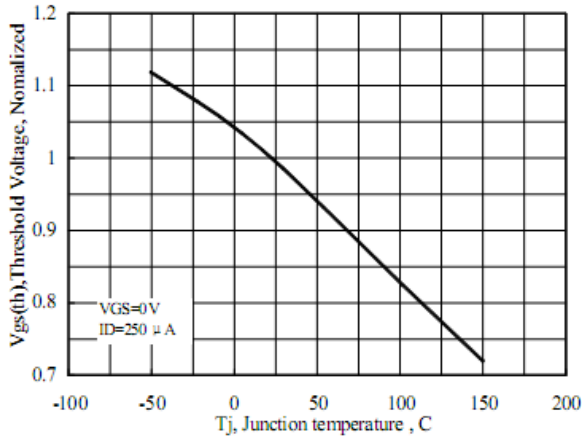

Figure 11 Typical Theshold Voltage vs Junction Temperature

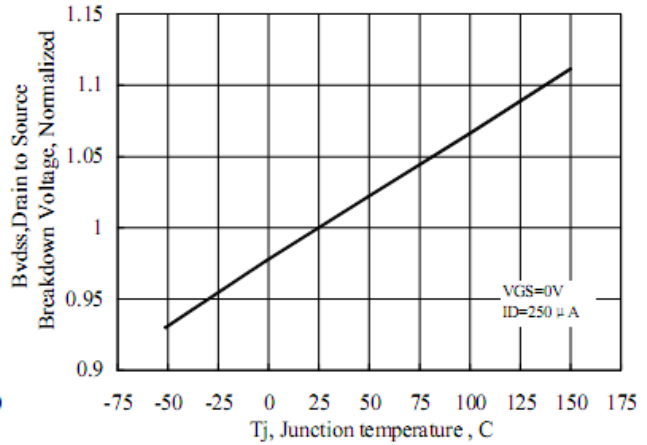

Figure 12 Typical Breakdown Voltage vs Junction Temperature

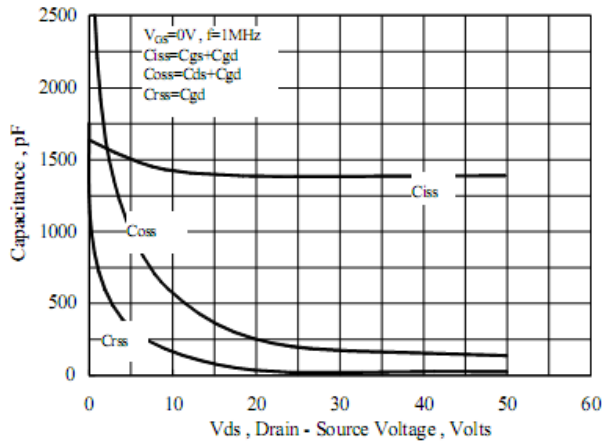

Figure 13 Typical Capacitance vs Drain to Source Voltage

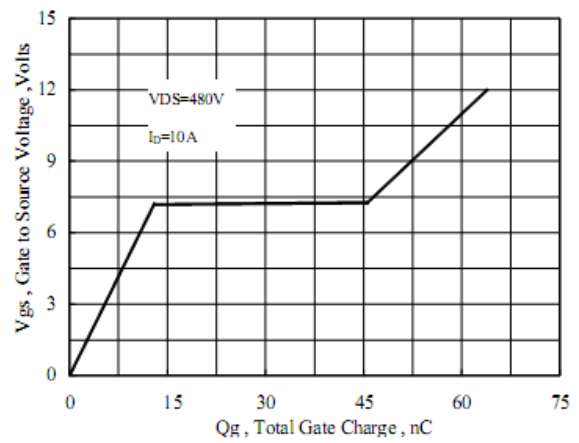

Figure 14 Typical Gate Charge vs Gate to Source Voltage

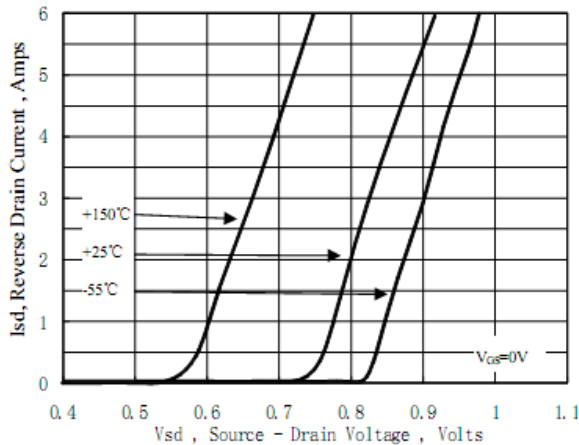

Figure 15 Typical Body Diode Transfer Characteristics

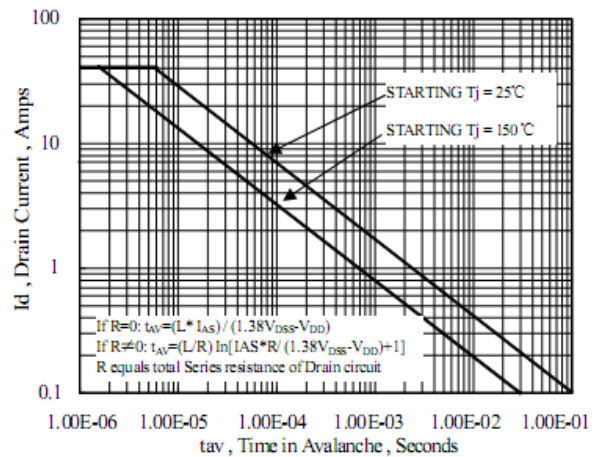

Figure 16 Unclamped Inductive Switching Capability

Test Circuit and Waveform

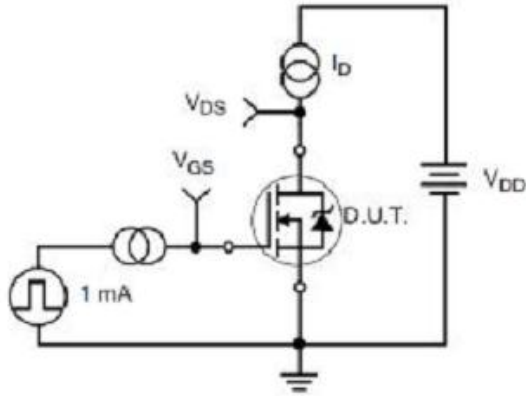

Figure 17. Gate Charge Test Circuit

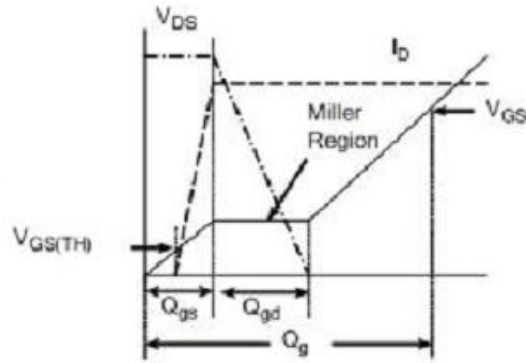

Figure 18. Gate Charge Waveform

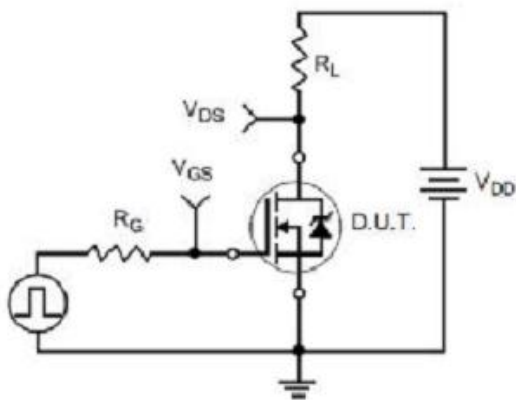

Figure 19. Resistive Switching Test Circuit

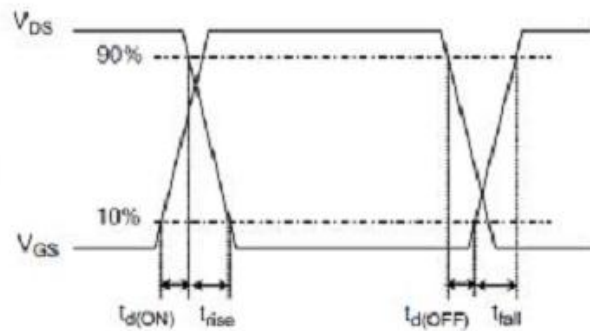

Figure 20. Resistive Switching Waveforms

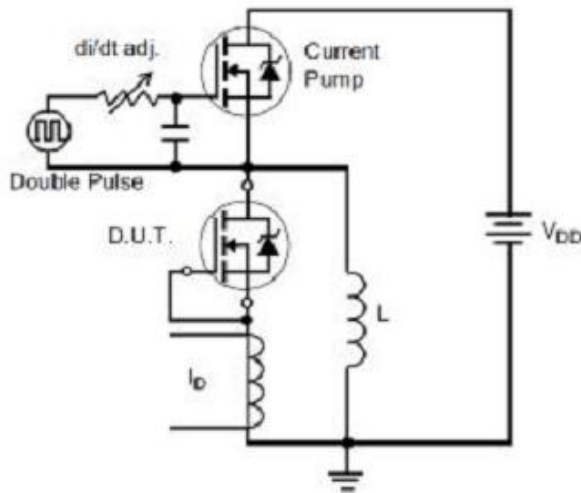

Figure 21. Diode Reverse Recovery Test Circuit

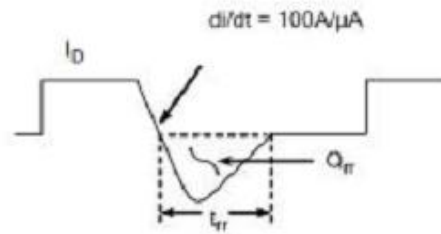

Figure 22. Diode Reverse Recovery Waveform

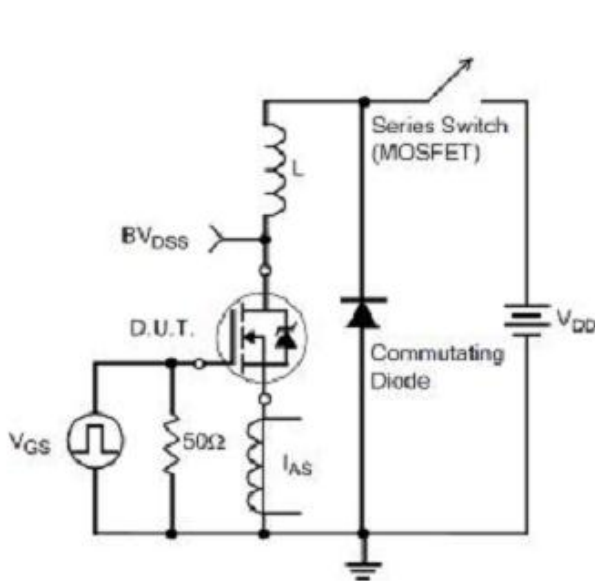

Figure 23. Unclamped Inductive Switching Test Circuit

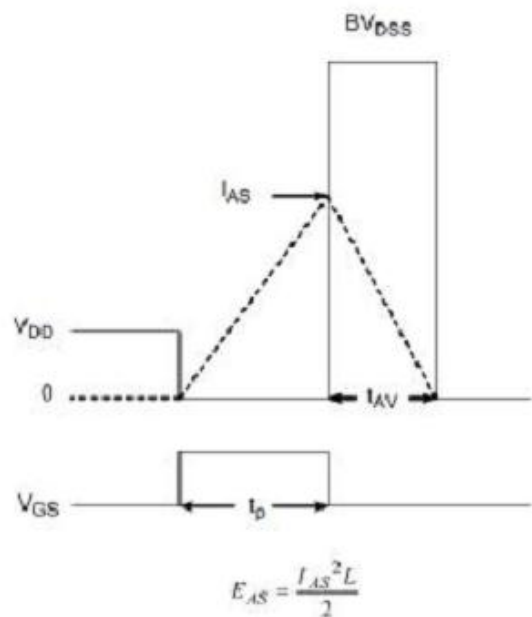
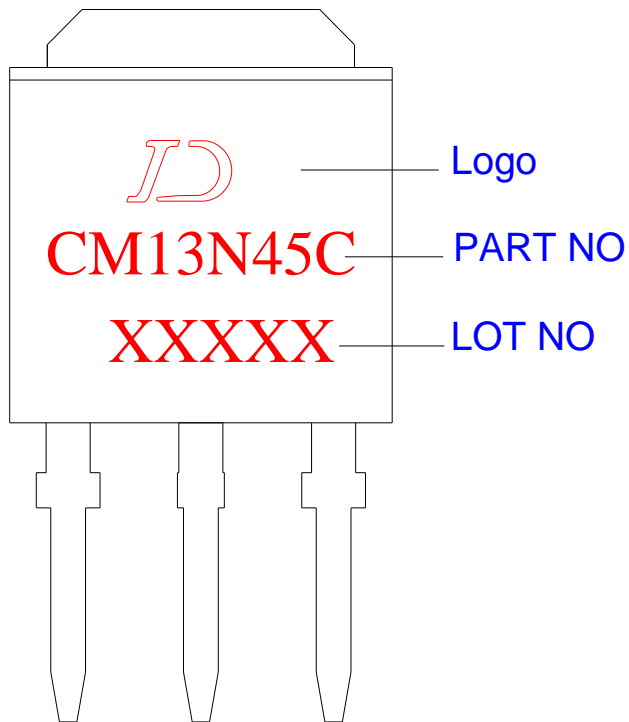

Figure 24. Unclamped Inductive Switching Waveforms



## 6. Marking (印章说明)



7. 产品外形尺寸图(单位: mm) Package Dimentions(Unit: mm)

T0-251S

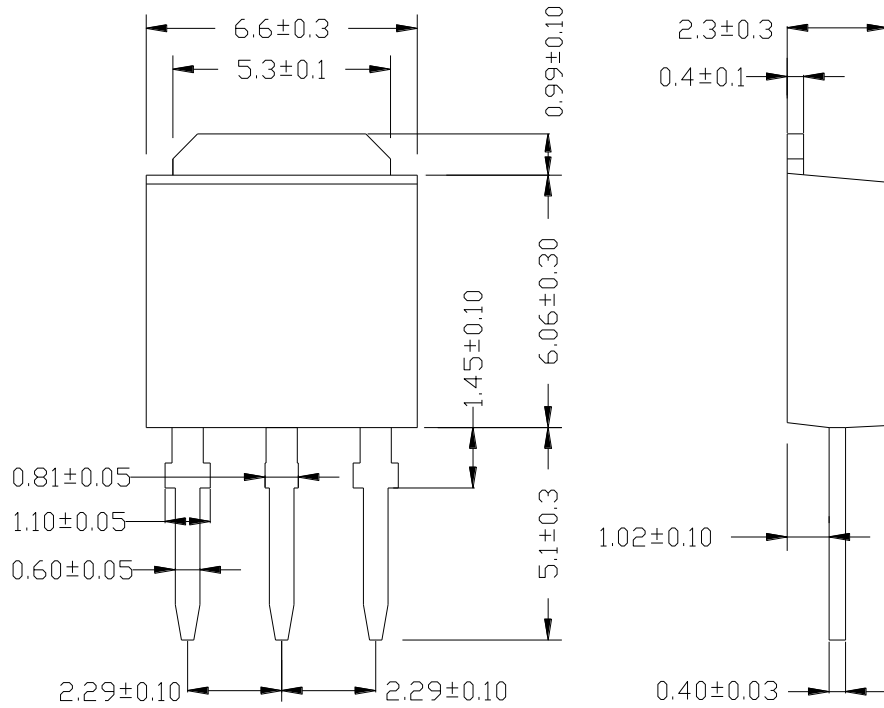

T0-252S

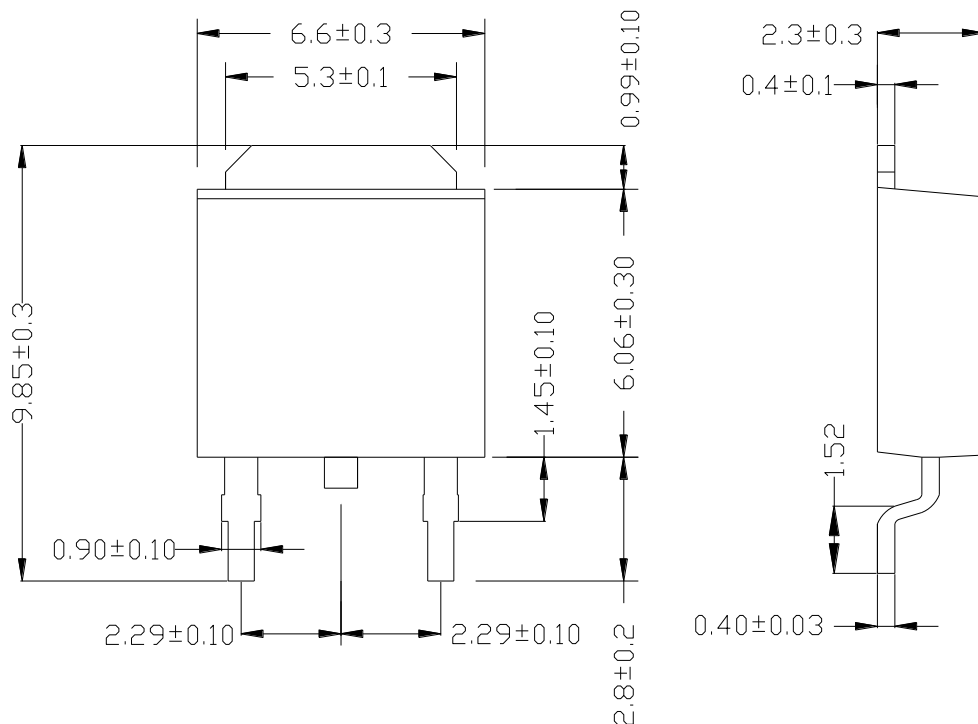



www.jdsemi.cn

深圳市晶导电子有限公司

ShenZhen Jingdao Electronic Co.,Ltd.

CM13N45C

POWER MOSFET

The name and content of poisonous and harmful material in products

Part's Name	Hazardous Substance					
	Pb	Hg	Cd	Cr(VI)	PBB	PBDE
Limit	≤0.1%	≤0.1%	≤0.01%	≤0.1%	≤0.1%	≤0.1%
Lead Frame	○	○	○	○	○	○
Molding Compound	○	○	○	○	○	○
Chip	○	○	○	○	○	○
Wire Bonding	○	○	○	○	○	○
Solder	×	○	○	○	○	○
Note	○: means the hazardous material is under the criterion of SJ/T11363-2006. ×: means the hazardous material exceeds the criterion of SJ/T11363-2006. The plumbum element of solder exist in products presently, but within the allowed range of Eurogroup's RoHS.					

Warnings

1. Exceeding the maximum ratings of the device in performance may cause damage to the device, even the permanent failure, which may affect the dependability of the machine. It is suggested to be used under 80 percent of the maximum ratings of the device.
2. When installing the heatsink, please pay attention to the torsional moment and the smoothness of the heatsink.
3. VDMOSFETs is the device which is sensitive to the static electricity, it is necessary to protect the device from being damaged by the static electricity when using it.
4. This publication is made by Jingdao Electronic and subject to regular change without notice.